



Yazd wire & cable Co.

World is lighted better with us!





Yazd wire & cable Co.

Yazd Wire & Cable Company



BETTER THAN EVERYONE

Yazd Wire and Cable Company established in a land with an area of 86000 m² in 1980. The company's manufacture was first limited to the wires.

In 1982, the first production hall with an area of 6000 m² was built and production continued with more diversity. After a while with the development approach to manufacturing activities, the second production hall with an area of 4800 m² was built in 1997 to increase the speed, quality and variety of production. In 2008 the third production hall with an area of 1000 m² was also built to produce lead sheathed cables.

Production of medium voltage cables in 2003 was began with installation and starting of special manufacturing equipment including the production line of insulating and screening and armouring of medium and high voltage cables and finally constructing the high voltage laboratory with 350 KV and power of 6000 VA.

With regard to the increasing demand for lead sheathed cables, this company planned to install and start the production lines of such cables. Therefore, with the purchase and installation of required machinery and equipment in 2008, the first lead sheathed cable was produced in 2009.

In 2010, regarding to specified objectives of increasing production volume, this company add the 8 wires production line to the available production lines & increase the production volume of I&C cables as much as 100 per cent.

According to the company's long-term strategy based upon keeping pace with the growth of technology, providing all machinery and equipment by the best and most reputable manufacturers has been made.



Yazd wire & cable Co.

Yazd Wire & Cable Company

- 1- High Voltage & medium voltage cable
- 2- LV CABLE
- 3- Control cable
- 4- Instrument cable
- 5- Aerial bundled cable
- 6- Fire resistant & Halogen free cable
- 7- Communication cable
- 8-Fieldbus cable
- 9- Flat cable
- 10- Marine & shipboard
- 11- Special cables
- 12- Wires



**LEADER OF WIRE AND CABLE
INDUSTRY.**

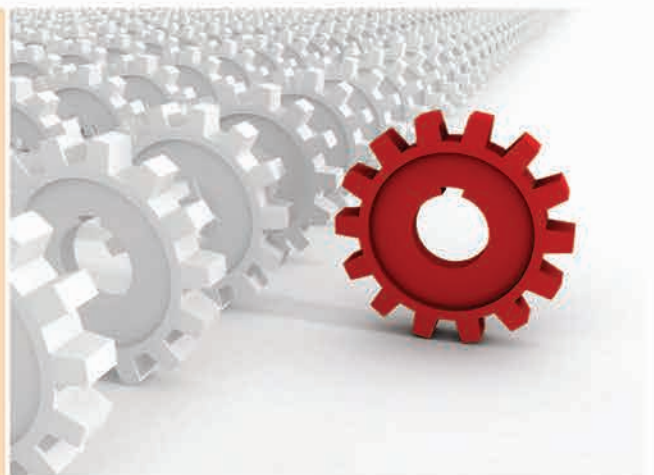

Type:
N2XSY-RM
CU/SC/XLPE/SC/SCT/CWS/PVC
RM:Stranded round conductor

Construction
1.Stranded copper conductor
2.Conductor screen/XLPE insulation/Insulation screen
3.Semi-conductive tape
4.Copper wire & tape screen
5.PVC outer sheath

XLPE insulated single core 6kv up to 230kv



Type:
NA2XSYRY-RM
AL/SC/XLPE/SC/SCT/CWS/PVC/AWA/PVC
RM:Stranded round conductor

Construction
1.Stranded Aluminum conductor
2.Conductor screen/XLPE insulation/Insulation screen
3.Semi-conductive tape
4.Copper wire & tape screen
5.PVC Separation sheath
6.Aluminum round wire armour
7.PVC outer sheath

XLPE insulated single core wire armoured 6kv up to 230kv



Type:
NA2XSYBY-RM
AL/SC/XLPE/SC/SCT/CWS/PVC/ATA/PVC
RM:Stranded round conductor

Construction
1.Stranded Aluminum conductor
2.Conductor screen/XLPE insulation/Insulation screen
3.Semi-conductive tape
4.Copper wire & tape screen
5.PVC Separation sheath
6.Aluminum tape armour
7.PVC outer sheath

XLPE insulated single core tape armoured 6kv up to 230kv



Type:
N2XSYKYRY-RM
CU/SC/XLPE/SC/SCT/CWS/PVC/LC/PVC/AWA/PVC
RM:Stranded round conductor

Construction
1.Stranded Copper conductor
2.Conductor screen/XLPE insulation/Insulation screen
/Semi-conductive tape
3.Copper wire & tape screen
4.PVC Inner sheath
5.Lead Sheath
6.PVC Separation sheath
7.Aluminum round wire armour
8.PVC outer sheath

XLPE insulated single core lead sheathed armoured 6kv up to 230kv



High Voltage & medium voltage cable

Type:
N2XSEY-RM, CU/SC/XLPE/SC/SCT/CWS/PVC/PVC
RM: Stranded round conductor

Construction
1. Stranded copper conductor
2. Conductor screen/XLPE insulation/Insulation screen /Semi-conductive tape
3. Copper wire & tape screen
4. PVC inner sheath
5. PVC outer sheath

XLPE insulated 3cores 6Kv up to 33Kv with wire & tape screen



Type:
N2XSEY-RM, CU/SC/XLPE/SC/SCT/CTS/PVC/PVC
RM: Stranded round conductor

Construction
1. Stranded copper conductor
2. Conductor screen/XLPE insulation/Insulation screen /Semi-conductive tape
3. Copper tape screen
4. PVC inner sheath
5. PVC outer sheath

XLPE insulated 3cores 6Kv up to 33Kv with tape screen

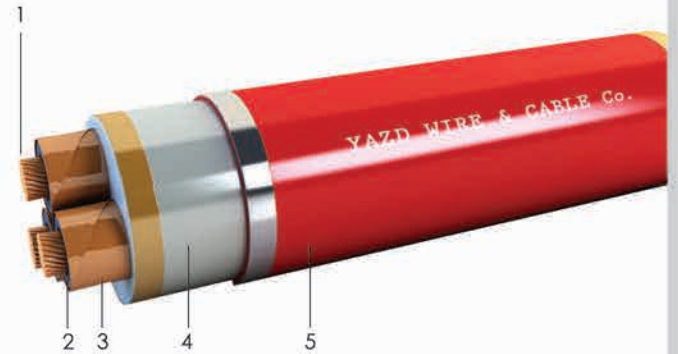

Type:
N2XSEYRY-RM, CU/SC/XLPE/SC/SCT/CWS/PVC/SWA/PVC
RM: Stranded round conductor

Construction
1. Stranded Copper conductor
2. Conductor screen/XLPE insulation/Insulation screen /Semi-conductive tape
3. Copper wire & tape screen
4. PVC inner sheath
5. PVC Separation sheath
6. Galvanized round steel wire armour
7. PVC outer sheath

XLPE insulated 3cores 6Kv up to 33Kv with wire plus tape screen & wire armoured



Type:
N2XSEYBY-RM, CU/SC/XLPE/SC/SCT/CWS/PVC/STA/PVC
RM: Stranded round conductor

Construction
1. Stranded Copper conductor
2. Conductor screen/XLPE insulation/Insulation screen /Semi-conductive tape
3. Copper wire & tape screen
4. PVC inner sheath
5. PVC Separation sheath
6. Galvanized steel tape armour
7. PVC outer sheath

XLPE insulated 3cores 6Kv up to 33Kv with tape screen & tape armoured



Type:
N2XSEYBY-RM, CU/SC/XLPE/SC/SCT/CWS/PVC/STA/PVC
RM:Stranded round conductor

- Construction**
- 1.Stranded Copper conductor
 - 2.Conductor screen/XLPE insulation/Insulation screen /Semi-conductive tape
 - 3.Copper wire & tape screen
 - 4.PVC inner sheath
 - 5.PVC Separation sheath
 - 6.Galvanized steel tape armour
 - 7.PVC outer sheath

XLPE insulated 3cores 6Kv up to 33kv with wire plus tape screen & tape armoured

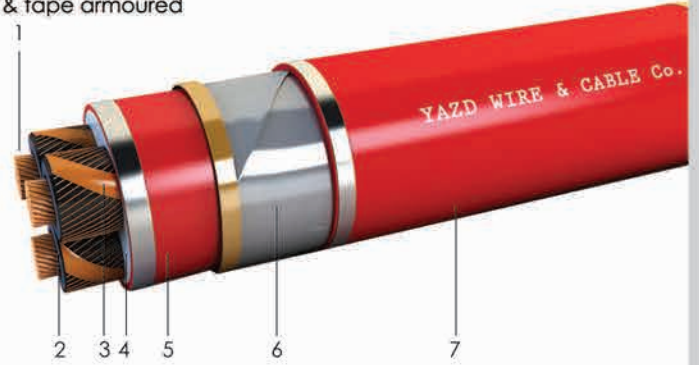

Type:
N2XSEYKYRY-RM, CU/SC/XLPE/SC/SCT/CWS/PVC/LC/PVC/SWA/PVC
RM:Stranded round conductor

- Construction**
- 1.Stranded Copper conductor
 - 2.Conductor screen/XLPE insulation/Insulation screen /Semi-conductive tape
 - 3.Copper wire & tape screen
 - 4.PVC Inner sheath
 - 5.Lead Sheath
 - 6.PVC Separation sheath
 - 7.Galvanized round steel wire armour
 - 8.PVC outer sheath

XLPE insulated 3cores 6Kv up to 33kv with wire plus tape screen ,lead sheathed & wire armoured



Type:
N2XSEYKYRY-RM, CU/SC/XLPE/SC/SCT/CTS/PVC/LC/PVC/SWA/PVC
RM:Stranded round conductor

- Construction**
- 1.Stranded Copper conductor
 - 2.Conductor screen/XLPE insulation/Insulation screen /Semi-conductive tape
 - 3.Copper tape screen
 - 4.PVC Inner sheath
 - 5.Lead Sheath
 - 6.PVC Separation sheath
 - 7.Galvanized round steel wire armour
 - 8.PVC outer sheath

XLPE insulated 3cores 6Kv up to 33kv with tape screen ,lead sheathed & wire armoured



Type:
 N2XY,NYY-RM
 CU/XLPE/PVC
 CU/PVC/PVC
RM:Stranded round conductor

Construction
 1.Stranded copper conductor
 2.XLPE or PVC Insulation
 3.PVC outer sheath

Copper conductor ,XLPE or PVC insulated



Type:
 NA2XY,NAYY-RM
 AL/XLPE/PVC
 AL/PVC/PVC
RM:Stranded round conductor

Construction
 1.Stranded Aluminum conductor
 2.XLPE or PVC Insulation
 3.PVC outer sheath

Aluminum conductor ,XLPE or PVC insulated



Type:
 N2XY,NYY-RM
 CU/XLPE/PVC/PVC
 CU/PVC/PVC/PVC
RM:Stranded round conductor

Construction
 1.Stranded copper conductor
 2.XLPE or PVC Insulation
 3.PVC Inner sheath
 4.PVC outer sheath

Round stranded copper conductor ,XLPE or PVC insulated



Type:
 N2XY,NYY-SM
 CU/XLPE/PVC
 CU/PVC/PVC
SM:Shaped Stranded conductor

Construction
 1.Stranded copper conductor
 2.XLPE or PVC Insulation
 3.PVC outer sheath

Shaped stranded copper conductor ,XLPE or PVC insulated



Type:
H03VV-F, H05VV-F, NYMHY-RF
CU/XLPE/PVC
CU/PVC/PVC
RF: Fine-Stranded conductor

Construction
1. Fine-Stranded copper conductor
2. XLPE or PVC Insulation
3. PVC outer sheath

Fine-stranded copper conductor ,XLPE or PVC insulated



Type:
NYCY, N2XCY-RE
CU/XLPE/CWS/PVC
CU/PVC/CWS/PVC
RE: Solid conductor

Construction
1. Solid copper conductor
2. XLPE or PVC Insulation
3. Copper wire screen
4. PVC outer sheath

Solid copper conductor ,XLPE or PVC insulated ,copper wire screen



Type:
NYCY, N2XCY-RM
CU/XLPE/PVC/CWS/PVC
CU/PVC/PVC/CWS/PVC
RM: Stranded round conductor

Construction
1. Semi-stranded copper conductor
2. XLPE or PVC Insulation
3. PVC inner sheath
4. Copper wire & tape screen
5. PVC outer sheath

Semi-stranded copper conductor ,XLPE or PVC insulated ,copper wire plus tape screen

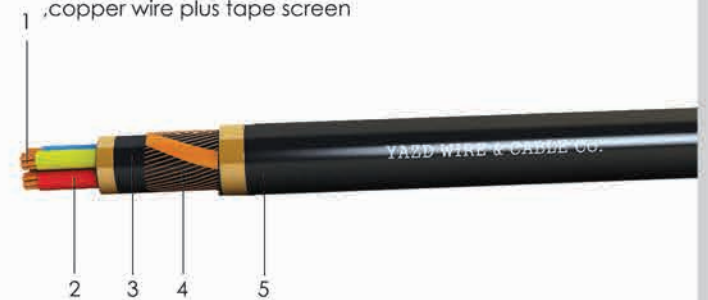

Type:
NYSLYCY, N2XCY-RF
CU/XLPE/PVC/CWB/PVC
CU/PVC/PVC/CWB/PVC
RF: Fine-Stranded conductor

Construction
1. Fine-Stranded copper conductor
2. XLPE or PVC Insulation
3. PVC inner sheath
4. Copper wire braided
5. PVC outer sheath

Fine-stranded copper conductor ,XLPE or PVC insulated ,copper wire braided screen



Type:
 NYRY,N2XRY-RM
 CU/XLPE/PVC/SWA/PVC
 CU/PVC/PVC/SWA/PVC
RM:Stranded round conductor

Construction
 1.Semi-stranded copper conductor
 2.XLPE or PVC Insulation
 3.PVC inner sheath
 4.Galvanized round steel wire armour
 5.PVC outer sheath

Semi-stranded copper conductor ,XLPE or PVC insulated ,wire armoured



Type:
 NYKYRY,N2XKYRY-RM
 CU/XLPE/PVC/LC/PVC/SWA/PVC
 CU/PVC/PVC/LC/PVC/SWA/PVC
RM:Stranded round conductor

Construction
 1.Semi-stranded copper conductor
 2.XLPE or PVC Insulation
 3.PVC inner sheath
 4.Lead sheath
 5.PVC separation sheath
 6.Galvanized round steel wire armour
 7.PVC outer sheath



Type:
 NYKYRY,N2XKYRY-SM
 CU/XLPE/PVC/LC/PVC/SWA/PVC
 CU/PVC/PVC/LC/PVC/SWA/PVC
SM:Shaped stranded conductor

Construction
 1.Semi-stranded copper conductor
 2.XLPE or PVC Insulation
 3.PVC inner sheath
 4.Lead sheath
 5.PVC separation sheath
 6.Galvanized round steel wire armour
 7.PVC outer sheath

Shaped stranded copper conductor ,XLPE or PVC insulated lead sheathed & wire armoured



Type:
 NYCYRY,N2XCYRY-SM
 CU/XLPE/PVC/CWS/PVC/SWA/PVC
 CU/PVC/PVC/CWS/PVC/SWA/PVC
SM:Shaped stranded conductor

Construction
 1.Semi-stranded copper conductor
 2.XLPE or PVC Insulation
 3.PVC inner sheath
 4.Copper wire & tape screen
 5.PVC separation sheath
 6.Galvanized round steel wire armour
 7.PVC outer sheath

Shaped stranded copper conductor ,XLPE or PVC insulated copper wire plus tape screen & wire armoured



Type:

NYCYKYRY,N2XCYKYRY-SM
 CU/XLPE/PVC/CWS/PVC/LC/PVC/SWA/PVC
 CU/PVC/PVC/CWS/PVC/LC/PVC/SWA/PVC
SM:Shaped stranded conductor

Construction

- 1.Semi-stranded copper conductor
- 2.XLPE or PVC Insulation
- 3.PVC inner sheath
- 4.Copper wire & tape screen
- 5.PVC inner sheath
- 6.Lead sheath
- 7.PVC separation sheath
- 8.Galvanized round steel wire armour
- 9.PVC outer sheath

Shaped stranded copper conductor ,XLPE or PVC insulated copper wire plus tape screen, lead sheathed & wire armoured

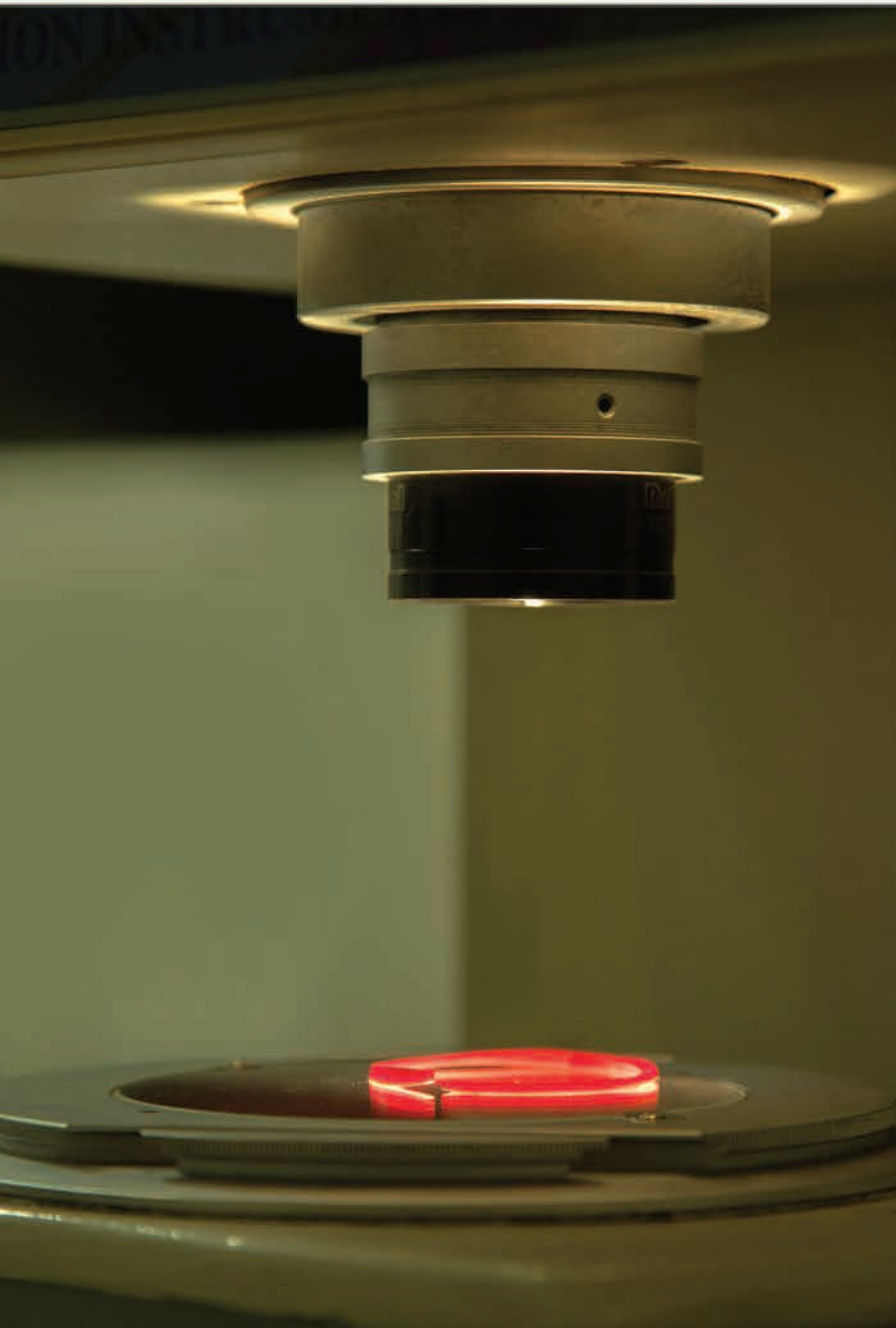

The highest quality

Control cable

Type:
H05VVf,NYSLY,NYY,N2XY-RF or RM
CU/XLPE/PVC
CU/PVC/PVC
RF:Fine-Stranded conductor
RM:Stranded round conductor

Construction
1.Stranded or fine-stranded copper conductor
2.XLPE or PVC Insulation
3.PVC outer sheath

Copper conductor ,PE,XLPE or PVC insulated



Type:
NYSLYCY,N2XCY-RF
CU/XLPE/PVC/CWB/PVC
CU/PVC/PVC/CWB/PVC
RF:Fine-Stranded conductor

Construction
1.Fine-Stranded copper conductor
2.XLPE or PVC Insulation
3.PVC inner sheath
4.Copper wire braided
5.PVC outer sheath

Copper conductor ,PE,XLPE or PVC insulated with copper braided screen



Type:
NYSY,N2XSY-RM
CU/XLPE/PVC/CTS/PVC
CU/PVC/PVC/CTS/PVC
RM:Stranded round conductor

Construction
1.Stranded copper conductor
2.XLPE or PVC Insulation
3.PVC inner sheath
4.Copper tape screen
5.PVC outer sheath

Copper conductor ,PE,XLPE or PVC insulated with copper tape screen



Type:
NYCY,N2XCY-RM
CU/XLPE/PVC/CWS/PVC
CU/PVC/PVC/CWS/PVC
RM:Stranded round conductor

Construction
1.Stranded copper conductor
2.XLPE or PVC Insulation
3.PVC inner sheath
4.Copper wire & tape screen
5.PVC outer sheath

Copper conductor ,PE,XLPE or PVC insulated with copper wire plus tape screen



Type:
 NYRY,N2XRY-RM
 CU/XLPE/PVC/SWA/PVC
 CU/PVC/PVC/SWA/PVC
RM:Stranded round conductor

Construction
 1.Semi-stranded copper conductor
 2.XLPE or PVC Insulation
 3.PVC inner sheath
 4.Galvanized round steel wire armour
 5.PVC outer sheath

Copper conductor ,PE,XLPE or PVC insulated ,wire armoured



Type:
 NYCYRY,N2XCYRY-RM
 CU/XLPE/PVC/CWS/PVC/SWA/PVC
 CU/PVC/PVC/CWS/PVC/SWA/PVC
RM:Stranded round conductor

Construction
 1.Semi-stranded copper conductor
 2.XLPE or PVC Insulation
 3.PVC inner sheath
 4.Copper wire & tape screen
 5.PVC separation sheath
 6.Galvanized round steel wire armour
 7.PVC outer sheath

Copper conductor ,PE,XLPE or PVC insulated ,copper wire plus tape screen&wire armoured



Type:
 NYKYRY,N2XKYRY-RM
 CU/XLPE/PVC/LC/PVC/SWA/PVC
 CU/PVC/PVC/LC/PVC/SWA/PVC
RM:Stranded round conductor

Construction
 1.Semi-stranded copper conductor
 2.XLPE or PVC Insulation
 3.PVC inner sheath
 4.Lead sheath
 5.PVC separation sheath
 6.Galvanized round steel wire armour
 7.PVC outer sheath

Copper conductor ,PE,XLPE or PVC insulated ,lead sheathed&wire armoured



Type:
 NYCYKYRY,N2XCYKYRY-RM
 CU/XLPE/PVC/CWS/PVC/LC/PVC/SWA/PVC
 CU/PVC/PVC/CWS/PVC/LC/PVC/SWA/PVC
RM:Stranded round conductor

Construction
 1.Semi-stranded copper conductor
 2.XLPE or PVC Insulation
 3.PVC inner sheath
 4.Copper wire & tape screen
 5.PVC inner sheath
 6.Lead sheath
 7.PVC separation sheath
 8.Galvanized round steel wire armour
 9.PVC outer sheath

Copper conductor ,PE,XLPE or PVC insulated ,copper wire plus tape screen,lead sheathed&wire armoured



Instrument cable

Type:
RE-Y(st)Y,RE-2X(st)Y,RE-2Y(st)Y
CU/XLPE or PE/OSCR/PVC
CU/PVC/OSCR/PVC
OSCR:Overall screen

Construction
1.Stranded copper conductor
2.Polyethylene,XLPE or PVC Insulation
3.Polyester tape
4.Tinned copper wire
5.Aluminum bonded to polyester tape
6.PVC outer sheath

Copper conductor ,PE , XLPE or PVC insulation,
twisted pair, overall screen



Type:
RE-Y(st)YRY,RE-2X(st)YRY,RE-2Y(st)YRY
CU/XLPE or PE/OSCR/PVC/SWA/PVC
CU/PVC/OSCR/PVC/SWA/PVC
OSCR:Overall screen

Construction
1.Stranded copper conductor
2.Polyethylene,XLPE or PVC Insulation
3.Polyester tape
4.Tinned copper wire
5.Aluminum bonded to polyester tape
6.PVC inner sheath
7.Galvanized round steel wire armour
8.PVC outer sheath

Copper conductor ,PE , XLPE or PVC insulation,
twisted pair, overall screen, wire armoured



Type:
RE-Y(st)YKYRY,RE-2X(st)YKYRY,RE-2Y(st)YKYRY
CU/XLPE or PE/OSCR/PVC/LC/PVC/SWA/PVC
CU/PVC/OSCR/PVC/LC/PVC/SWA/PVC
OSCR:Overall screen

Construction
1.Stranded copper conductor
2.Polyethylene,XLPE or PVC Insulation
3.Polyester tape
4.Tinned copper wire
5.Aluminum bonded to polyester tape
6.PVC inner sheath
7.Lead sheath
8.PVC inner sheath
9.Galvanized round steel wire armour
10.PVC outer sheath

Copper conductor ,PE , XLPE or PVC insulation,
twisted pair, overall screen, lead sheathed, wire armoured

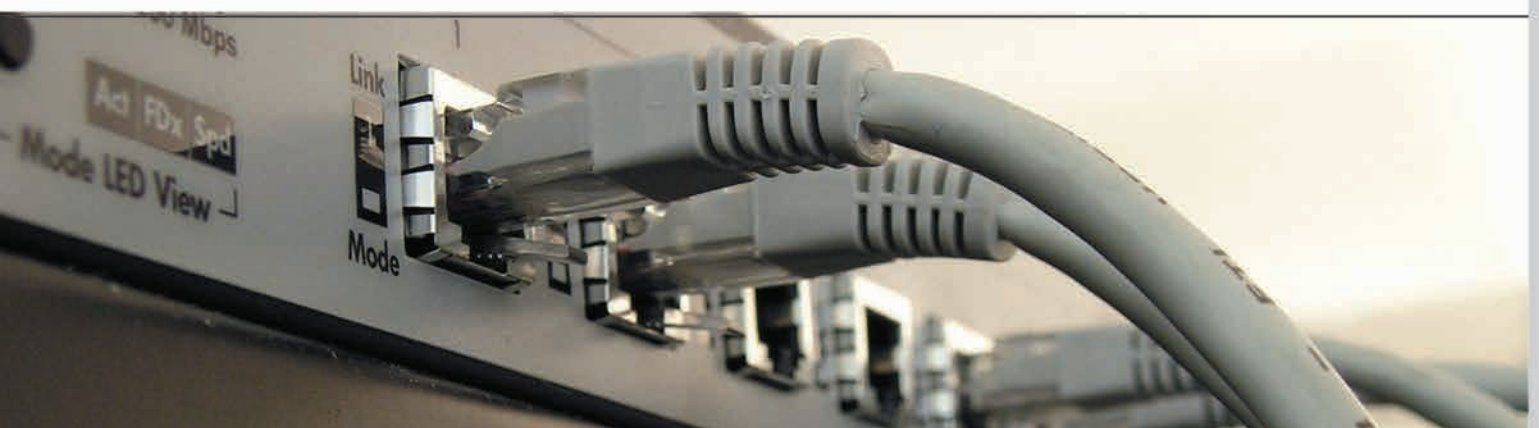

Instrument cable

Type:
 RE-Y(st)Y,RE-2X(st)Y-RE-2Y(st)Y-PIMF
 CU/XLPE or PE/ISCR/OSCR/PVC
 CU/PVC/ISCR/OSCR/PVC
ISCR:Individual screen
OSCR:Overall screen
PIMF:Pair in metal foil

Construction
 1.Stranded copper conductor
 2.Polyethylene,XLPE or PVC Insulation
ISCR
 3.Polyester tape
 4.Tinned copper wire
 5.Aluminum bonded to polyester tape
OSCR
 6.Polyester tape
 7.Tinned copper wire
 8.Aluminum bonded to polyester tape
 9.PVC outer sheath

Copper conductor ,PE , XLPE or PVC insulation,
 twisted pair, individual & overall screen



Type:
 RE-Y(st)YRY,RE-2X(st)YRY-RE-2Y(st)YRY-PIMF
 CU/XLPE or PE/ISCR/OSCR/PVC/SWA/PVC
 CU/PVC/ISCR/OSCR/PVC/SWA/PVC
ISCR:Individual screen
OSCR:Overall screen
PIMF:Pair in metal foil

Construction
 1.Stranded copper conductor
 2.Polyethylene,XLPE or PVC Insulation
ISCR
 3.Polyester tape
 4.Tinned copper wire
 5.Aluminum bonded to polyester tape
OSCR
 6.Polyester tape
 7.Tinned copper wire
 8.Aluminum bonded to polyester tape

9.PVC inner sheath
 10.Galvanized round steel wire armour
 11.PVC outer sheath

Copper conductor ,PE , XLPE or PVC insulation,
 twisted pair, individual & overall screen, wire armoured



Type:
 RE-Y(st)YKYRY,RE-2X(st)YKYRY-RE-2Y(st)YKYRY-PIMF
 CU/XLPE or PE/ISCR/OSCR/PVC/LC/PVC/SWA/PVC
 CU/PVC/ISCR/OSCR/PVC/LC/PVC/SWA/PVC
ISCR:Individual screen
OSCR:Overall screen
PIMF:Pair in metal foil

Construction
 1.Stranded copper conductor
 2.Polyethylene,XLPE or PVC Insulation
ISCR
 3.Polyester tape
 4.Tinned copper wire
 5.Aluminum bonded to polyester tape
OSCR
 6.Polyester tape
 7.Tinned copper wire
 8.Aluminum bonded to polyester tape

9.PVC inner sheath
 10.Lead sheath
 11.PVC inner sheath
 12.Galvanized round steel wire armour
 13.PVC outer sheath

Copper conductor ,PE , XLPE or PVC insulation,
 twisted pair, individual & overall screen, lead sheathed
 & wire armoured



Instrument cable

Type:
RE-Y(st)Y,RE-2X(st)Y,RE-2Y(st)Y-PIMF
CU/XLPE or PE/ISCR/PVC/OSCR/PVC
CU/PVC/ISCR/PVC/OSCR/PVC
ISCR:Individual screen
OSCR:Overall screen
PIMF:Pair in metal foil

Construction
1.Stranded copper conductor
2.Polyethylene,XLPE or PVC Insulation
ISCR
3.Polyester tape
4.Tinned copper wire
5.Aluminum bonded to polyester tape
6.PVC pair jacket
OSCR
7.Polyester tape
8.Tinned copper wire
9.Aluminum bonded to polyester tape

10.PVC outer sheath

Copper conductor ,PE , XLPE or PVC insulation,
twisted pair, individual & overall screen with pair jacket



Type:
RE-Y(st)YRY,RE-2X(st)YRY,RE-2Y(st)YRY-PIMF
CU/XLPE or PE/ISCR/PVC/OSCR/PVC/SWA/PVC
CU/PVC/ISCR/PVC/OSCR/PVC/SWA/PVC
ISCR:Individual screen
OSCR:Overall screen
PIMF:Pair in metal foil

Construction
1.Stranded copper conductor
2.Polyethylene,XLPE or PVC Insulation
ISCR
3.Polyester tape
4.Tinned copper wire
5.Aluminum bonded to polyester tape
6.PVC pair jacket
OSCR
7.Polyester tape
8.Tinned copper wire
9.Aluminum bonded to polyester tape

10.PVC inner sheath
11.Galvanized round steel wire armour
12.PVC outer sheath

Copper conductor ,PE , XLPE or PVC insulation,
twisted pair, individual & overall screen with pair jacket ,
wire armoured



Type:
RE-Y(st)YKYRY,RE-2X(st)YKYRY,RE-2Y(st)YKYRY-PIMF
CU/XLPE or PE/ISCR/PVC/OSCR/PVC/LC/PVC/SWA/PVC
CU/PVC/ISCR/PVC/OSCR/PVC/LC/PVC/SWA/PVC
ISCR:Individual screen
OSCR:Overall screen
PIMF:Pair in metal foil

Construction
1.Stranded copper conductor
2.Polyethylene,XLPE or PVC Insulation
ISCR
3.Polyester tape
4.Tinned copper wire
5.Aluminum bonded to polyester tape
6.PVC pair jacket
OSCR
7.Polyester tape
8.Tinned copper wire
9.Aluminum bonded to polyester tape

10.PVC inner sheath
11.Lead sheath
12.PVC inner sheath
13.Galvanized round steel wire armour
14.PVC outer sheath

Copper conductor ,PE , XLPE or PVC insulation,
twisted pair, individual & overall screen with pair jacket
lead sheathed & wire armoured



Type:
MV Aerial Bundled Cable (ABC) up to 33KV
AL/SC/XLPE/SC/SCT/CWS/PVC or HDPE

Construction
1. Aluminum copper conductor
2. Conductor screen/XLPE insulation/Insulation screen.
3. Semi-conductive tape
4. Copper wire & tape screen
5. PVC or HDPE outer sheath

→ Bare or Insulated Galvanized steel Messenger

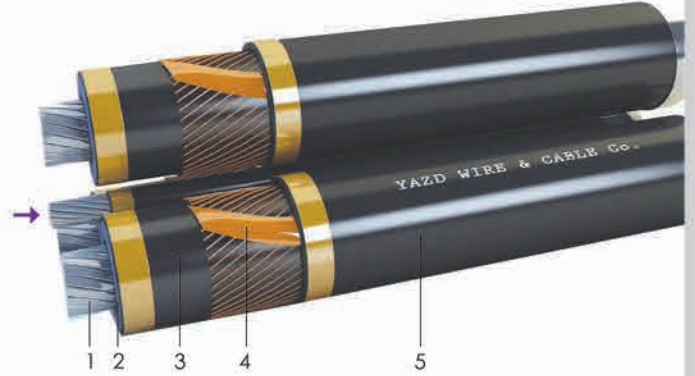

Type:
LV Aerial Bundled Cable (ABC)
AL/XLPE

Construction
1. Stranded aluminum conductor
2. Insulated or bare aluminum alloy neutral messenger
3. XLPE Insulation

Aluminum conductor, XLPE insulated with
Aluminum alloy neutral messenger



Type:
LV Aerial Bundled Cable (ABC)
AL/XLPE

Construction
1. Stranded aluminum conductor
2. Insulated or bare galvanized steel support
3. XLPE Insulation

Aluminum conductor, XLPE insulated with
galvanized steel support



Fire resistant & Halogen free cable

Type:
N2XH-FI-RM
CU/MGT/XLPE/LSHF/LSHF
RM:Stranded round conductor
FI:Fire resistant

Construction
1.Stranded copper conductor
2.Mica glass tape
3.XLPE Insulation
4.LSHF Inner sheath
5.LSHF outer sheath

Copper conductor ,mica glass tape plus XLPE insulation

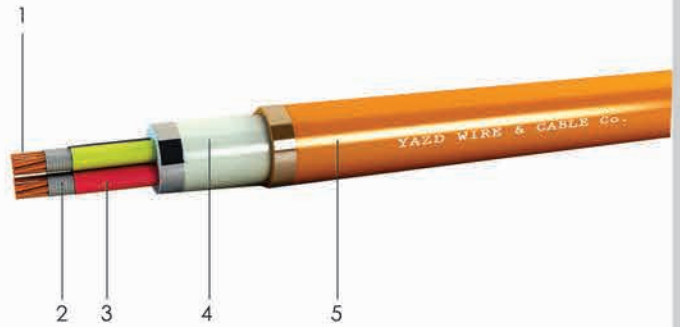

Type:
N2XRH-FI-RM
CU/MGT/XLPE/LSHF/SWA/LSHF
RM:Stranded round conductor
FI:Fire resistant

Construction
1.Semi-stranded copper conductor
2.Mica glass tape
3.XLPE Insulation
4.LSHF inner sheath
5.Galvanized round steel wire armour
6.LSHF outer sheath

Copper conductor ,mica glass tape plus XLPE insulation ,wire armoured

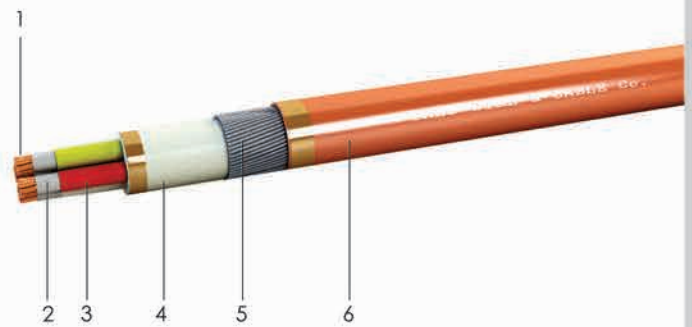

Type:
N2XRH-FI-RM
CU/MGT/XLPE/LSHF/SWA/LSHF
RM:Stranded round conductor
FI:Fire resistant

Construction
1.Semi-stranded copper conductor
2.Mica glass tape
3.XLPE Insulation
4.LSHF inner sheath
5.Galvanized round steel wire armour
6.LSHF outer sheath

Copper conductor ,mica glass tape plus XLPE insulation ,wire armoured

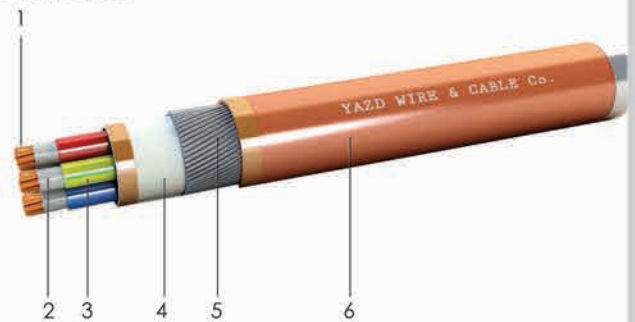

Type:
N2XCH-FI-RM
CU/MGT/XLPE/LSHF/CWS/LSHF
RM:Stranded round conductor
FI:Fire resistant

Construction
1.Semi-stranded copper conductor
2.Mica glass tape
3.XLPE Insulation
4.LSHF inner sheath
5.Copper wire & tape screen
6.LSHF outer sheath

Copper conductor ,mica glass tape plus XLPE insulation ,copper wire plus tape screen

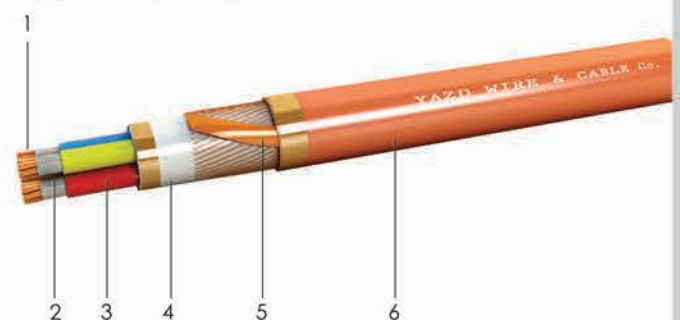

Type:
N2XCHRH-FI-RM
CU/MGT/XLPE/LSHF/CWS/LSHF/SWA/LSHF
RM:Stranded round conductor
FI:Fire resistant

Construction
1.Semi-stranded copper conductor
2.Mica glass tape
3.XLPE insulation
4.LSHF inner sheath
5.Copper wire & tape screen
6.LSHF separation sheath
7.Galvanized round steel wire armour
8.LSHF outer sheath

Copper conductor ,mica glass tape plus XLPE insulation ,copper wire plus tape screen & wire armoured



Type:
N2XHHRH-FI-RM
CU/MGT/XLPE/LSHF/LC/LSHF/SWA/LSHF
RM:Stranded round conductor
FI:Fire resistant

Construction
1.Semi-stranded copper conductor
2.Mica glass tape
3.XLPE insulation
4.LSHF inner sheath
5.Lead sheath
6.LSHF separation sheath
7.Galvanized round steel wire armour
8.LSHF outer sheath

Copper conductor ,mica glass tape plus XLPE insulation ,lead sheathed & wire armoured



Type:
N2XCHKHRH-FI-RM
CU/MGT/XLPE/LSHF/CWS/LSHF/LC/LSHF/SWA/LSHF
RM:Stranded round conductor
FI:Fire resistant

Construction
1.Semi-stranded copper conductor
2.Mica glass tape
2.XLPE insulation
3.LSHF inner sheath
4.Copper wire & tape screen
5.LSHF inner sheath
6.Lead sheath
7.LSHF separation sheath
8.Galvanized round steel wire armour
9.LSHF outer sheath

Copper conductor ,mica glass tape plus XLPE insulation ,copper wire plus tape screen,lead sheathed & wire armoured



Fire resistant & Halogen free cable

Type:
N2XH-FI-RM
CU/MGT/XLPE/LSHF
RM:Stranded round conductor
FI:Fire resistant

Construction
1.Stranded copper conductor
2.Mica glass tape
3.XLPE insulation
4.LSHF outer sheath

Copper conductor ,mica glass tape plus XLPE insulation



Type:
N2XCH-FI-RM
CU/MGT/XLPE/LSHF/CWS/LSHF
RM:Stranded round conductor
FI:Fire resistant

Construction
1.Stranded copper conductor
2.Mica glass tape
3.XLPE insulation
4.LSHF inner sheath
5.Copper wire & tape screen
6.LSHF outer sheath

Copper conductor ,mica glass tape plus XLPE insulation, copper wire plus tape screen



Type:
N2XRH-FI-RM
CU/MGT/XLPE/LSHF/SWA/LSHF
RM:Stranded round conductor
FI:Fire resistant

Construction
1.Semi-stranded copper conductor
2.Mica glass tape
3.XLPE insulation
4.LSHF inner sheath
5.Galvanized round steel wire armour
6.LSHF outer sheath

Copper conductor ,mica glass tape plus XLPE insulation, wire armoured



Type:
N2XCHRH-FI-RM
CU/MGT/XLPE/LSHF/CWS/LSHF/SWA/LSHF
RM:Stranded round conductor
FI:Fire resistant

Construction
1.Semi-stranded copper conductor
2.Mica glass tape
3.XLPE insulation
4.LSHF inner sheath
5.Copper wire & tape screen
6.LSHF separation sheath
7.Galvanized round steel wire armour
8.LSHF outer sheath

Copper conductor ,mica glass tape plus XLPE insulation, copper wire plus tape screen, wire armoured

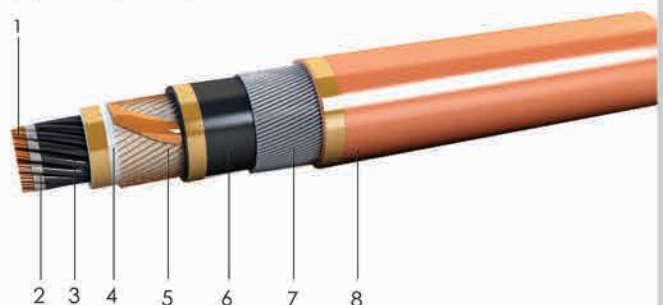

Type:
 N2XKHRH-FI-RM
 CU/MGT/XLPE/LSHF/LC/LSFH/SWA/LSHF
RM: Stranded round conductor
FI: Fire resistant

- Construction**
1. Semi-stranded copper conductor
 2. Mica glass tape
 3. XLPE Insulation
 4. LSHF inner sheath
 5. Lead sheath
 6. LSHF separation sheath
 7. Galvanized round steel wire armour
 8. LSHF outer sheath

Copper conductor ,mica glass tape plus XLPE insulation ,
 lead sheathed , wire armoured

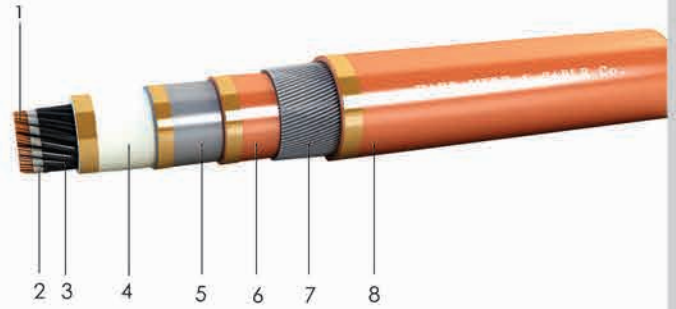

Type:
 N2XCHKHRH-FI-RM
 CU/MGT/XLPE/LSHF/CWS/LSHF/LC/LSHF/SWA/LSHF
RM: Stranded round conductor
FI: Fire resistant

- Construction**
1. Semi-stranded copper conductor
 2. Mica glass tape
 3. XLPE Insulation
 4. LSHF inner sheath
 5. Copper wire & tape screen
 6. LSHF inner sheath
 7. Lead sheath
 8. LSHF separation sheath
 9. Galvanized round steel wire armour
 10. LSHF outer sheath

Copper conductor ,mica glass tape plus XLPE insulation ,
 copper wire plus tape screen, lead sheathed , wire armoured

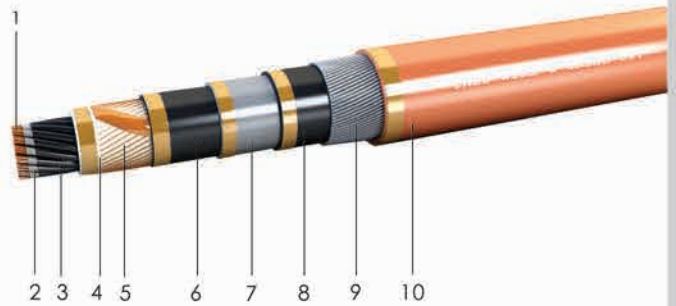

Fire me if you can!!

Fire resistant & Halogen free cable

Type:
RE-2X(st)H-FI
CU/MGT/XLPE/OSCR/LSHF
OSCR:Overall screen
FI:Fire resistance

Construction
1.Stranded copper conductor
2.Mica glass tape
3.XLPE Insulation
4.Polyester tape
5.Tinned copper wire
6.Aluminum bonded to polyester tape
7.LSHF outer sheath

Copper conductor ,mica glass tape plus XLPE insulation, twisted pair, overall screen

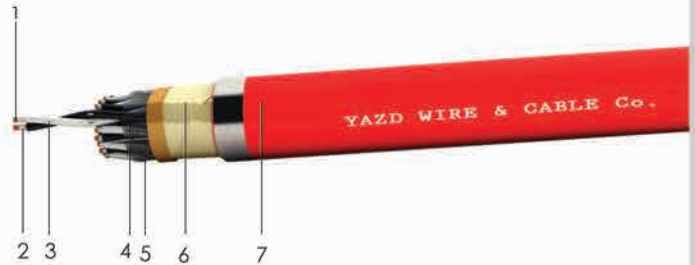

Type:
RE-2X(st)HRH-FI
CU/MGT/XLPE/OSCR/LSHF/SWA/LSHF
OSCR:Overall screen
FI:Fire resistance

Construction
1.Stranded copper conductor
2.Mica glass tape
3.XLPE Insulation
4.Polyester tape
5.Tinned copper wire
6.Aluminum bonded to polyester tape
7.LSHF inner sheath
8.Galvanized round steel wire armour
9.LSHF outer sheath

Copper conductor ,mica glass tape plus XLPE insulation, twisted pair, overall screen, wire armoured



Type:
RE-2X(st)HKHRH-FI
CU/MGT/XLPE/OSCR/LSHF/LC/LSHF/SWA/LSHF
OSCR:Overall screen
FI:Fire resistance

Construction
1.Stranded copper conductor
2.Mica glass tape
3.XLPE Insulation
4.Polyester tape
5.Tinned copper wire
6.Aluminum bonded to polyester tape
7.LSHF inner sheath
8.Lead sheath
9.LSHF inner sheath
10.Galvanized round steel wire armour
11.LSHF outer sheath

Copper conductor ,mica glass tape plus XLPE insulation, twisted pair, overall screen, lead sheathed, wire armoured



we enjoy being in fire

Type:
RE-2X(st)H-PIMF-Fi
CU/MGT/XLPE/ISCR/OSCR/LSHF
ISCR:Individual screen
OSCR:Overall screen
PIMF:Pair in metal foil
Fi:Fire resistance

Construction
1.Stranded copper conductor
2.Mica glass tape
3.XLPE insulation
ISCR
4.Polyester tape
5.Tinned copper wire
6.Aluminum bonded to polyester tape
OSCR
7.Polyester tape
8.Tinned copper wire
9.Aluminum bonded to polyester tape

10.LSHF outer sheath

Copper conductor ,mica glass tape plus XLPE insulation, twisted pair, individual & overall screen



Type:
RE-2X(st)HRH-PIMF-Fi
CU/MGT/XLPE/ISCR/OSCR/LSHF/SWA/LSHF
ISCR:Individual screen
OSCR:Overall screen
PIMF:Pair in metal foil
Fi:Fire resistance

Construction
1.Stranded copper conductor
2.Mica glass tape
3.XLPE insulation
ISCR
4.Polyester tape
5.Tinned copper wire
6.Aluminum bonded to polyester tape
OSCR
7.Polyester tape
8.Tinned copper wire
9.Aluminum bonded to polyester tape

10.LSHF inner sheath
11.Galvanized round steel wire armour
12.LSHF outer sheath

Copper conductor ,mica glass tape plus XLPE insulation, twisted pair, individual & overall screen, wire armoured

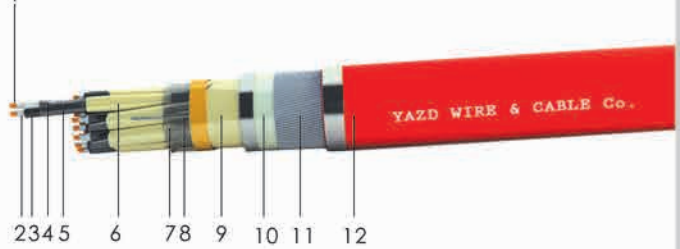

Type:
RE-2X(st)HKHRH-PIMF-Fi
CU/MGT/XLPE/ISCR/OSCR/LSHF/LC/LSHF/SWA/LSHF
ISCR:Individual screen
OSCR:Overall screen
PIMF:Pair in metal foil
Fi:Fire resistance

Construction
1.Stranded copper conductor
2.Mica glass tape
3.XLPE insulation
ISCR
4.Polyester tape
5.Tinned copper wire
6.Aluminum bonded to polyester tape
OSCR
7.Polyester tape
8.Tinned copper wire
9.Aluminum bonded to polyester tape

10.LSHF inner sheath
11.Lead sheath
12.LSHF inner sheath
13.Galvanized round steel wire armour
14.LSHF outer sheath

Copper conductor ,mica glass tape plus XLPE insulation, twisted pair, individual & overall screen, lead sheathed & wire armoured



Fire resistant & Halogen free cable

Type:
RE-2X(st)H-PIMF-Fi
CU/MGT/XLPE/ISCR/LSHF/OSCR/LSHF
ISCR:Individual screen
OSCR:Overall screen
PIMF:Pair in metal foil
Fi:Fire resistance

Construction

- 1.Stranded copper conductor
- 2.Mica glass tape
- 3.XLPE insulation
- ISCR**
- 4.Polyester tape
- 5.Tinned copper wire
- 6.Aluminum bonded to polyester tape
- 7.LSHF pair jacket
- OSCR**
- 8.Polyester tape
- 9.Tinned copper wire
- 10.Aluminum bonded to polyester tape

11.LSHF outer sheath

Copper conductor ,mica glass tape plus XLPE insulation, twisted pair, individual & overall screen with pair jacket



Type:
RE-2X(st)HRH-PIMF-Fi
CU/MGT/XLPE/ISCR/LSHF/OSCR/LSHF/SWA/LSHF
ISCR:Individual screen
OSCR:Overall screen
PIMF:Pair in metal foil
Fi:Fire resistance

Construction

- 1.Stranded copper conductor
- 2.Mica glass tape
- 3.XLPE insulation
- ISCR**
- 4.Polyester tape
- 5.Tinned copper wire
- 6.Aluminum bonded to polyester tape
- 7.LSHF pair jacket
- OSCR**
- 8.Polyester tape
- 9.Tinned copper wire
- 10.Aluminum bonded to polyester tape

11.LSHF inner sheath
12.Galvanized round steel wire armour
13.LSHF outer sheath

Copper conductor ,mica glass tape plus XLPE insulation, twisted pair, individual & overall screen with pair jacket , wire armoured

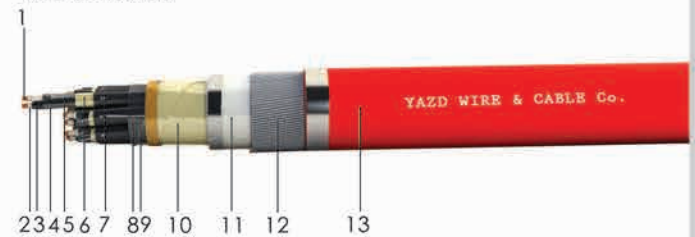

Type:
RE-2X(st)HKHRH-PIMF-Fi
CU/MGT/XLPE/ISCR/LSHF/OSCR/LSHF/LC/LSHF/SWA/LSHF
ISCR:Individual screen
OSCR:Overall screen
PIMF:Pair in metal foil
Fi:Fire resistance

Construction

- 1.Stranded copper conductor
- 2.Mica glass tape
- 3.XLPE insulation
- ISCR**
- 4.Polyester tape
- 5.Tinned copper wire
- 6.Aluminum bonded to polyester tape
- 7.LSHF pair jacket
- OSCR**
- 8.Polyester tape
- 9.Tinned copper wire
- 10.Aluminum bonded to polyester tape

11.LSHF inner sheath
12.Lead sheath
13.LSHF inner sheath
14.Galvanized round steel wire armour
15.LSHF outer sheath

Copper conductor ,mica glass tape plus XLPE insulation, twisted pair, individual & overall screen with pair jacket ,lead sheathed & wire armoured



We don't know yet !!!!

Type:
50 Ω, 75 Ω ,RG Series
3C-2V,4.5C-2V,7C-2V,10C-2V,3D-2V,etc.
RG6,RG11,RG59,etc.

Construction
1.Stranded or solid copper conductor
2.Foamed or solid PE Insulation
3.First braided copper shield
4.PVC inner sheath
5.Second braided copper shield
6.PVC outer sheath

Foamed or solid PE insulated ,overall double braided screen



Type:
50 Ω, 75 Ω ,RG Series
3C-2V,4.5C-2V,7C-2V,10C-2V,3D-2V,etc.
RG6,RG11,RG59,etc.

Construction
1.Stranded or solid copper conductor
2.Foamed or solid PE Insulation
3.Braided copper shield
4.Black PVC outer sheath

Foamed or solid PE insulated ,overall braided screen



Type:
50 Ω, 75 Ω ,RG Series
3C-2V,4.5C-2V,7C-2V,10C-2V,3D-2V,etc.
RG6,RG11,RG59,etc.

Construction
1.Stranded or solid copper conductor
2.Foamed or solid PE Insulation
3.Braided copper shield
4.White PVC outer sheath

Foamed or solid PE insulated ,overall braided screen



you can have the best Communication.



Communication cable

Type:

J-Y(st)Y, JE-Y(st)Y, A-2Y(st)2Y, etc.
 CU/PVC/OSCR/PVC
 CU/PE/OSCR/PE
OSCR: Overall screen

Construction

1. Solid copper conductor
2. Polyethylene or PVC Insulation
3. Polyester tape
4. Tinned copper wire
5. Aluminum bonded to polyester tape
6. PVC or Polyethylene outer sheath

Plained or Tinned copper conductor ,PE or PVC insulated with overall screen



Type:

J-Y(st)YRY, JE-Y(st)YRY, A-2Y(st)2YR2Y, etc.
 CU/PVC/OSCR/PVC/SWA/PVC
 CU/PE/OSCR/PE/SWA/PE
OSCR: Overall screen

Construction

1. Solid copper conductor
2. Polyethylene or PVC Insulation
3. Polyester tape
4. Tinned copper wire
5. Aluminum bonded to polyester tape
6. PVC or Polyethylene inner sheath
7. Galvanized round steel wire armour
8. PVC or Polyethylene outer sheath

Plained or Tinned copper conductor ,PE or PVC insulated with overall screen & wire armoured

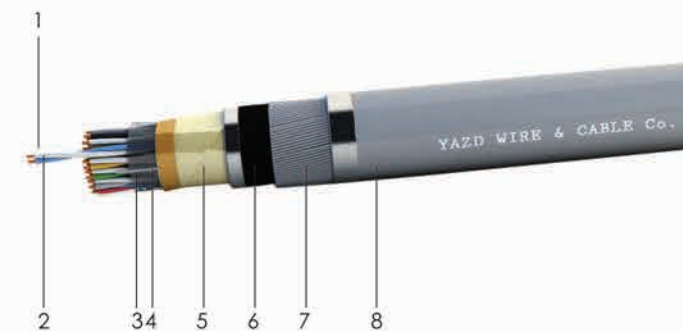

Type:

J-Y(st)YKYRY, JE-Y(st)YKYRY, A-2Y(st)2YK2YR2Y, etc.
 CU/PVC/OSCR/PVC/LC/PVC/SWA/PVC
 CU/PE/OSCR/PE/LC/PE/SWA/PE
OSCR: Overall screen

Construction

1. Solid copper conductor
2. Polyethylene or PVC Insulation
3. Polyester tape
4. Tinned copper wire
5. Aluminum bonded to polyester tape
6. PVC or Polyethylene inner sheath
7. Lead sheath
8. PVC or Polyethylene inner sheath
9. Galvanized round steel wire armour
10. PVC or Polyethylene outer sheath

Plained or Tinned copper conductor ,PE or PVC insulated with overall screen , lead sheathed & wire armoured

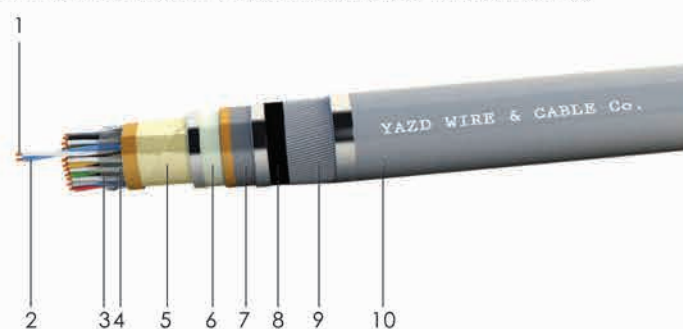

Type:
LAN CAT6 UTP
CU/PE/PVC

Construction
1.Solid copper conductor
2.Polyethylene Insulation
3.PVC outer sheath

Copper conductor ,PE insulated twisted pair

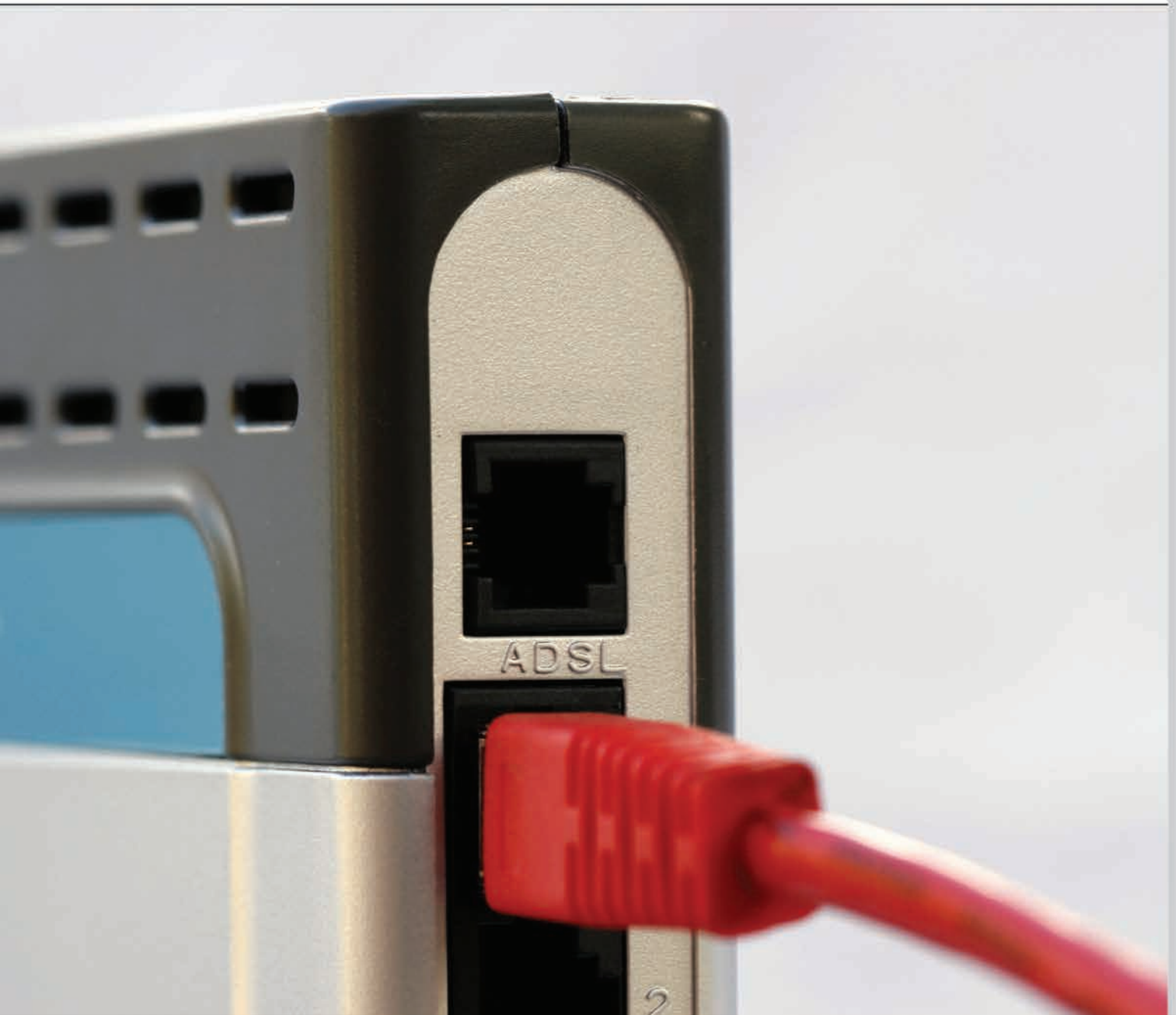

Fieldbus cable

Type:
RE-Y(st)Y,RE-2X(st)Y,RE-2Y(st)Y
CU/XLPE or PE/OSCR/PVC
CU/PVC/OSCR/PVC
OSCR:Overall screen

Construction
1.Stranded copper conductor
2.Polyethylene,XLPE or PVC Insulation
3.Polyester tape
4.Tinned copper wire
5.Aluminum bonded to polyester tape
6.PVC outer sheath

Plained or Tinned copper conductor ,PE or XLPE insulated with overall screen

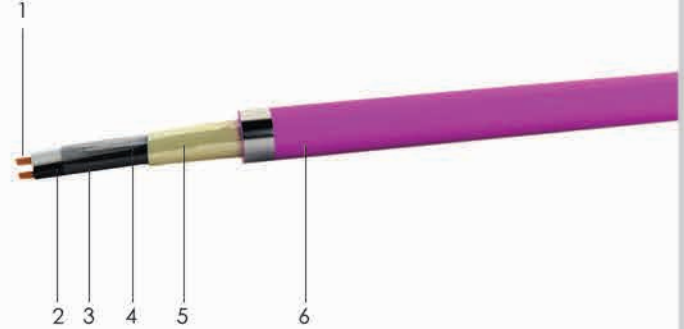

Type:
RE-Y(st)YRY,RE-2X(st)YRY,RE-2Y(st)YRY
CU/XLPE or PE/OSCR/PVC/SWA/PVC
CU/PVC/OSCR/PVC/SWA/PVC
OSCR:Overall screen

Construction
1.Stranded copper conductor
2.Polyethylene,XLPE or PVC Insulation
3.Polyester tape
4.Tinned copper wire
5.Aluminum bonded to polyester tape
6.PVC inner sheath
7.Galvanized round steel wire armour
8.PVC outer sheath

Plained or Tinned copper conductor ,PE or XLPE insulated with overall screen & wire armoured

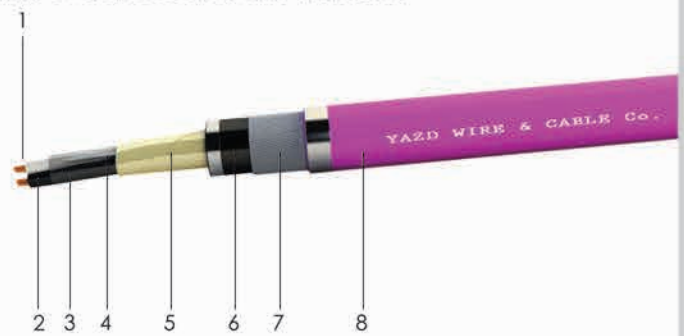

Type:
RE-Y(st)YKYRY,RE-2X(st)YKYRY,RE-2Y(st)YKYRY
CU/XLPE or PE/OSCR/PVC/LC/PVC/SWA/PVC
CU/PVC/OSCR/PVC/LC/PVC/SWA/PVC
OSCR:Overall screen

Construction
1.Stranded copper conductor
2.Polyethylene,XLPE or PVC Insulation
3.Polyester tape
4.Tinned copper wire
5.Aluminum bonded to polyester tape
6.PVC inner sheath
7.Lead sheath
8.PVC inner sheath
9.Galvanized round steel wire armour
10.PVC outer sheath

Plained or Tinned copper conductor ,PE or XLPE insulated with overall screen , lead sheathed & wire armoured

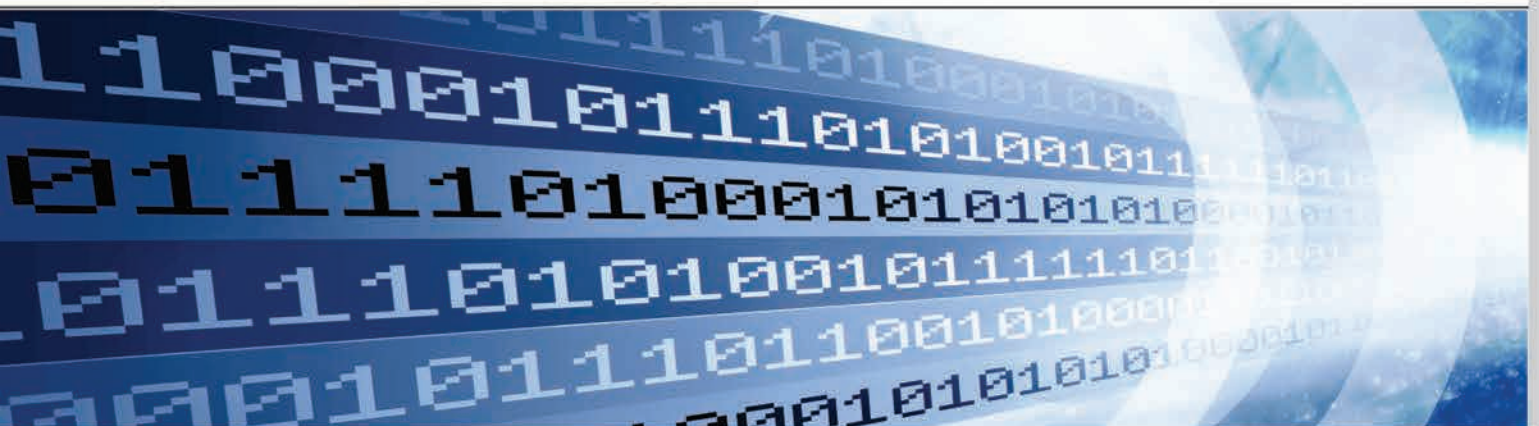
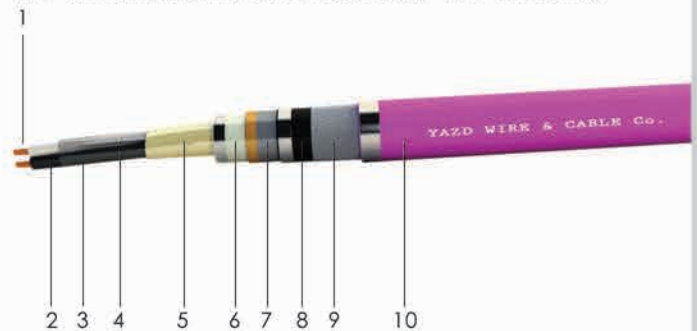

Type:

H05VVH2-F, H03VVH2-F, H07VVH6-F, MYFLY
CU/PVC/PVC

Construction

1. Fine-stranded copper conductor
2. PVC Insulation
3. PVC outer sheath (2 Paralleled cores)

Copper conductor ,PVC insulated , 2 Paralleled cores



Type:

H05VVH2-F, H03VVH2-F, H07VVH6-F, MYFLY
CU/PVC/PVC

Construction

1. Fine-stranded copper conductor
2. PVC Insulation
3. PVC outer sheath (3 Paralleled cores)

Copper conductor ,PVC insulated , 3 Paralleled cores

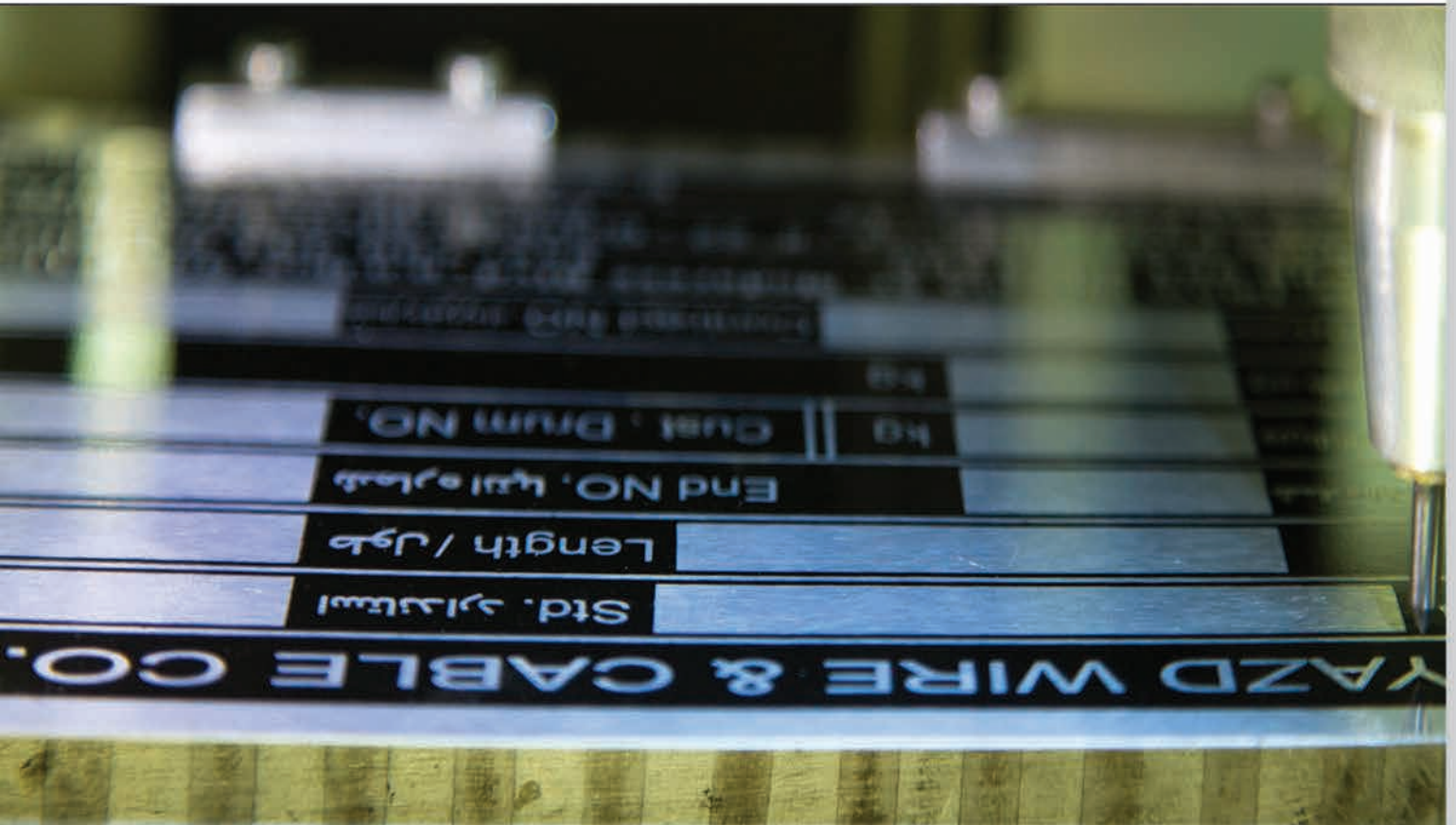

Type:
 NYCY,N2XCY-RF or RM
 TI-CU/XLPE/PVC/TI-CWB/PVC
 TI-CU/PVC/PVC/TI-CWB/PVC
RF:Fine-Stranded conductor
RM:Stranded round conductor

Construction
 1.Fine or Semi-Stranded tinned copper conductor
 2.XLPE or PVC Insulation
 3.PVC inner sheath
 4.Tinned Copper wire braided
 5.PVC outer sheath

Low voltage power cable ,stranded tinned copper conductor ,XLPE or PVC insulated,tinned copper wire braided screen



Type:
 NYSLYCY,N2XCY-RF or RM
 TI-CU/XLPE/PVC/TI-CWB/PVC
 TI-CU/PVC/PVC/TI-CWB/PVC
RF:Fine-Stranded conductor
RM:Stranded round conductor

Construction
 1.Fine or Semi-Stranded tinned copper conductor
 2.XLPE or PVC Insulation
 3.PVC inner sheath
 4.Tinned Copper wire braided
 5.PVC outer sheath

Control cable , Stranded tinned copper conductor ,XLPE or PVC insulated tinned copper wire braided screen



Type:
 TI-CU/XLPE or PE/ISCR/OSCR/PVC/SWB/PVC
 TI-CU/PVC/ISCR/OSCR/PVC/SWB/PVC
ISCR:Individual Tinned copper braided screen
OSCR:Overall Aluminum bonded to polyester tape screen
PIMF:Pair in metal foil
SWB:Galvanized steel wire braided

Construction
 1.Stranded copper conductor
 2.Polyethylene,XLPE or PVC Insulation
 3.Polyester tape
 4.Tinned copper wire braided
 5.Polyester tape
 6.Polyester tape
 7.Tinned copper wire
 8.Aluminum bonded to polyester tape
 9.PVC inner sheath
 10.Galvanized steel wire braided armour
 11.PVC outer sheath

Instrumentation cable , tinned copper conductor ,PE , XLPE or PVC insulation,twisted pair, individual & overall tinned copper braided screen, wire braided armoured



Type:

TOPFLEX-EMV*-3 PLUS 2YSLCY-J
CU/PE/PVC/OSCR/PVC

OSCR: Overall double screen

Construction

1. Fine-Stranded copper conductor
2. Polyethylene insulation
3. PVC inner sheath
4. Aluminum bonded to polyester tape
5. tinned copper braided screen
6. PVC outer sheath



Composite cables for special applications such as mine, airport, Paging and Aviation Industries are producible.

Construction

Hard-Drawn Electrolytic-Copper wire accordance with IEC & ASTM standards.

Semi-stranded copper conductor



Type:

H05V-U, H07V-R, NYA

CU/PVC

CU/LSHF

R: Stranded conductor

U: Solid conductor

Construction

1. Stranded copper conductor

2. PVC or halogen free Insulation (Erthing wire)

Semi-stranded copper conductor, PVC or Low smoke halogen free insulated



Type:

H05V-U, H07V-R, NYA

CU/PVC

CU/LSHF

R: Stranded conductor

U: Solid conductor

Construction

1. Stranded copper conductor

2. PVC or halogen free Insulation

Semi-stranded copper conductor, PVC or Low smoke halogen free insulated



Type:

H05V-K, H07V-K, NYAF

CU/PVC

CU/LSHF

K: Stranded conductor

Construction

1. Fine-stranded copper conductor

2. PVC or halogen free Insulation

Fine-stranded copper conductor, PVC or Low smoke halogen free insulated





Construction

Hard-Drawn Aluminum or Aluminum magnesium & silicon wire accordance with IEC, DIN, BS & ASTM standards.

Type:

Dog, Hyena, Mink, Fox & etc.
50/8, 70/12, 95/15, 120/20, 150/25, 185/30, 240/40 & etc.
accordance with DIN, BS & ASTM standards.

Construction

1. Galvanized steel wire
2. Hard-Drawn Aluminum wire
(The conductors can be internally protected with appropriate grease if required.)

Type:

Aerial Covered Conductor (CC) up to 33KV
CU/XLPE

Construction

1. Aluminum or aluminium alloy conductor
2. XLPE insulation

Type:

Aerial Covered Conductor (CC) up to 33KV
CU/XLPE

Construction

1. Galvanized steel wire
2. Hard-Drawn Aluminum wire
3. XLPE insulation



Aluminium or aluminium alloy conductor, XLPE insulated



Aluminium conductor steel Reinforced (ACSR), XLPE insulated







Yazd Office : Imam hossain st. - Shahid Modarres Blvd. -Yazd -Iran
Postal code : 8944168173
Tel : +98 35 3825 1200 Fax : +98 35 3825 4865
Tehran Office: 6th Floor-No.22- Golshahr Blvd.- Africa Expway-Tehran -Iran
Postal code : 1915663669
Tel : +98 21 22012211 - 12 , 22053752 Fax : +98 21 22053760
www.yazdcable.com email:info@yazdcable.com

www.bastan.co
+98 912 936 6084
Farhad Ostadan

World is lighted better with us!

